





TAQUILLAS FENÓLICAS

PHENOLIC LOCKERS

VESTIAIRES EN STRATIFIÉ

CACIFOS DE RESINAS FENÓLICAS

CARACTERÍSTICAS / CHARACTERISTICS / CARACTERISTIQUES / CARACTERISTICAS



Tornillería y bisagras en acero inoxidable.  
Screws and hinges in stainless steel.  
Vis et charnières en acier inoxydable.  
Parafusos e dobradiças em aço inox.

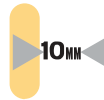

Espesores.  
Thicknesses.  
Épaisseurs.  
Espessura.



Pata regulable en altura.  
Legs adjustable in height.  
Pieds réglables en hauteur.  
Pés reguláveis em altura.

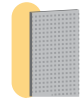

Trasera en tablex perforado y totalmente enmarcada.  
Back panel made of perforated tablex and totally framed.  
Partie arrière en tablex perforé et totalement encadrée.  
Parte de atrás construída em tablex perfurado e totalmente encaixada.



Cantos redondeados.  
Rounded edges.  
Sans arête vive.  
Cantos redondeados.



Placa de numeración incluida.  
Numeration plate included.  
Plaque numérique inclus.  
Placa de numeração inclusa.



Recomendado para ambientes húmedos. Resistente al agua. Waterproof.  
Recommended for wet areas. Waterproof.  
Récommandé pour les environnements humides.  
Recomendado para lugares com humidade. Resistente a água.



Cuerpo.  
Body.  
Corps.  
Corpo.



Gran resistencia.  
Great resistance.  
Très résistant.  
Muito resistente.



Cerradura de resbalón con bombillo extraíble y llave maestra.  
Latch operated lock with removable cylinder and master key.  
Serrure à plaquer avec cylindre enlevable et clé passe.  
Fechadura de segurança com possibilidade de tirar o cilindro e chave mestre.



Fácil limpieza.  
Easy cleaning.  
Nettoyage facile.  
Fácil limpeza.



Material de gran resistencia, hidrófugo, ignífugo y antibacteriano.  
Material of great resistance, hydrophobic, fire resistant and antibacterial.  
Matériel très résistant, hydrofuge, ignifuge et antibactérien.  
Material muito resistente, hidrófugo, ignífugo e antibacteriano.

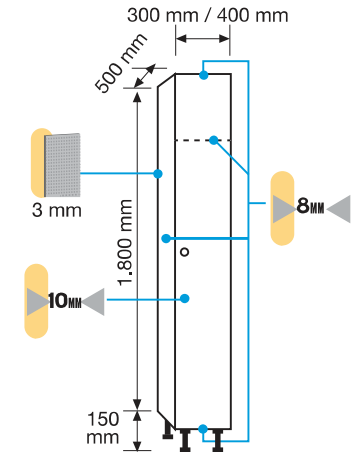

OPCIONES / OPTIONS / OPTIONS / OPÇÕES

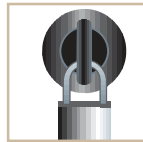

Pomo en poliamida (candado opcional)  
Padlockable Polyamide Lock (optional padlock)  
Poignée cadénassable en polyamide (cadenas en option)  
Fechadura de cadeado em poliamida



Pomo metálico (candado combinación opcional)  
Padlockable Metallic Lock (optional combination padlock)  
Poignée métallique (cadenas à combinaison en option)  
Fechadura de cadeado em metal



Monedero (moneda retornable).  
Coin-operated Lock (coin-return).  
Monnayeur (monnaie réversible).  
Moedeiro (moeda retornável).



Monedero + cajetín depósito.  
Coin-operated Lock + Coin Collect Box (cash box, non coin-return).  
Monnayeur + tirelire (monnaie non réversible).  
Moedeiro + caixinha para as moedas.



Cerradura electrónica de combinación de 4 dígitos.  
Electronic lock combination of 4 digits.  
Serrure électronique à combinaison de 4 chiffres.  
Fechadura electrónica, combinação de 4 dígitos.



Cerradura de proximidad  
Lock of proximity  
Serrure de proximité  
Fechadura de proximidade



Cerradura electrónica de combinación de 4 dígitos.  
Electronic lock combination of 4 digits.  
Serrure électronique à combinaison de 4 chiffres.  
Fechadura electrónica, combinação de 4 dígitos.



Cerradura electrónica de combinación de 4 dígitos.  
Electronic lock combination of 4 digits.  
Serrure électronique à combinaison de 4 chiffres.  
Fechadura electrónica, combinação de 4 dígitos.



Cerradura de proximidad  
Lock of proximity  
Serrure de proximité  
Fechadura de proximidade



Cerradura de proximidad  
Lock of proximity  
Serrure de proximité  
Fechadura de proximidade



Cerradura de combinación y llave de emergencia  
Lock of 4 manual digits with emergency key  
Serrure à combinaison et clef de émergence  
Fechadura de combinação e chave de emergência



Cerradura electrónica de combinación de 4 dígitos.  
Electronic lock combination of 4 digits.  
Serrure électronique à combinaison de 4 chiffres.  
Fechadura electrónica, combinação de 4 dígitos.



Cerradura electrónica de combinación de 4 dígitos.  
Electronic lock combination of 4 digits.  
Serrure électronique à combinaison de 4 chiffres.  
Fechadura electrónica, combinação de 4 dígitos.



Bisagra a 180°  
180° hinge opening  
Charnière a 180°  
Dobradiça a 180°

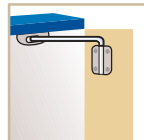

Retenedor de puerta a 90°  
Door opening limiter 90°  
Entrebâilleur de porte à 90 degrés  
Retentor para porta a 90 graus

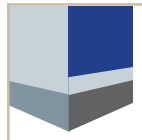

Zócalo melamina  
Melamine Socle  
Mélamine Socle  
Base de melamina



Lateral embellecedor  
Decorative end panel  
Enjoliveur latéral  
Lateral de feituração



Sobretecho inclinado  
Slope Top  
Toit incliné  
Sobreteito com pequena inclinação



Cierre para candado  
Closing for padlock  
Fermeture pour cadenas  
Fechadura para cadeado



Pulsera de nylon  
Bracelet of nylon  
Bracelet en nylon  
Pulseira de náilon



Pulsera elástica  
Elastic Bracelet  
Bracelet élastique  
Pulseira elástica



SERIE FV

SERIE FT

SERIE FM

SERIE FC

SERIE FP

SERIE FB

SERIE FZ

SERIE FL

5

**COLORES STANDARD PUERTAS / STANDARD DOORS COLOURS / COULEURS PORTES STANDARD / CORES DE PORTAS STANDARD**



FBLANCO-1

FH-162

FV-097

FX-027

FK-096

FY-018

FY-571

FF-036

FF-087

FT-100

FV-021

FL-021

FF-623

FM-168

FM-100

FM-200

FF-405

OTROS COLORES CONSULTAR / OTHER COLOURS ON REQUEST / AUTRES COULEURS SUR DEMANDE / OUTRAS CORES PERGUNTAR

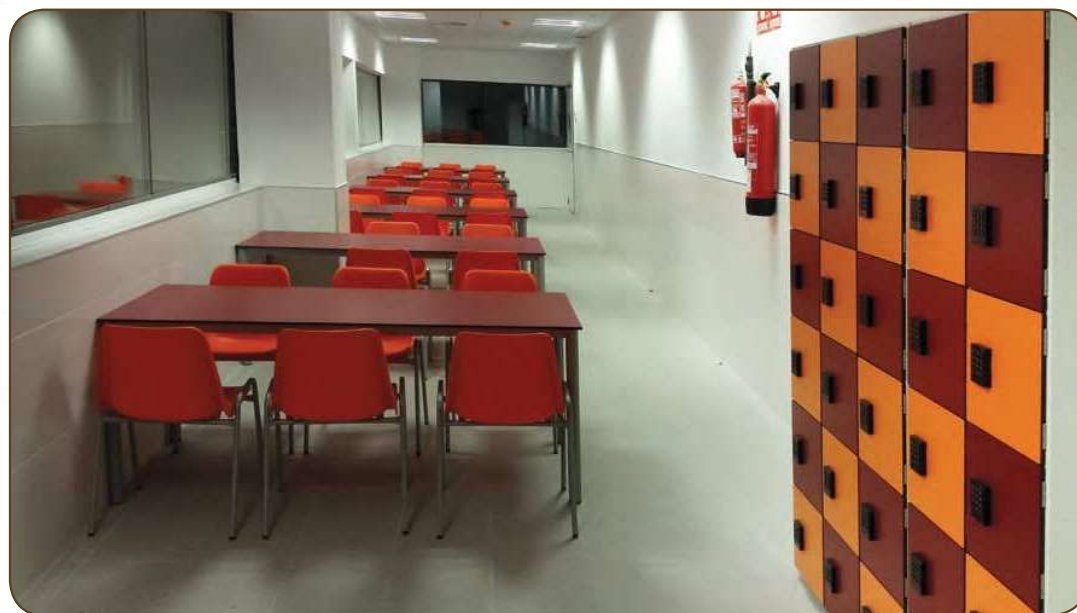



SERIE FV

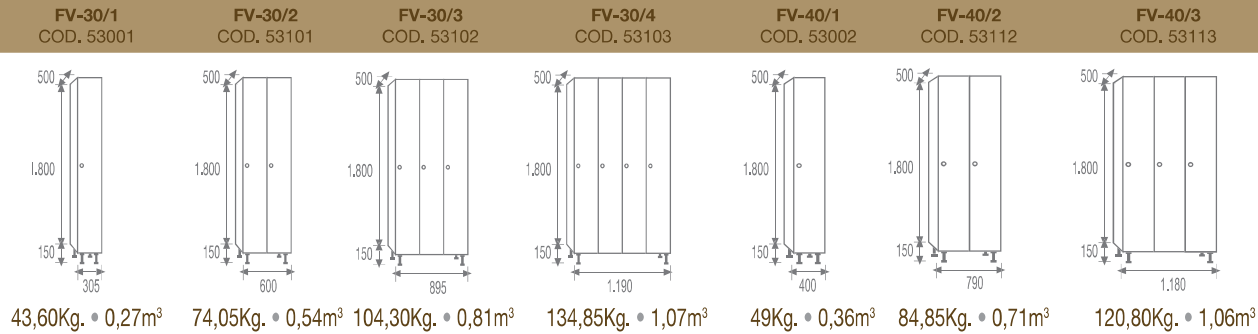

SERIE FT

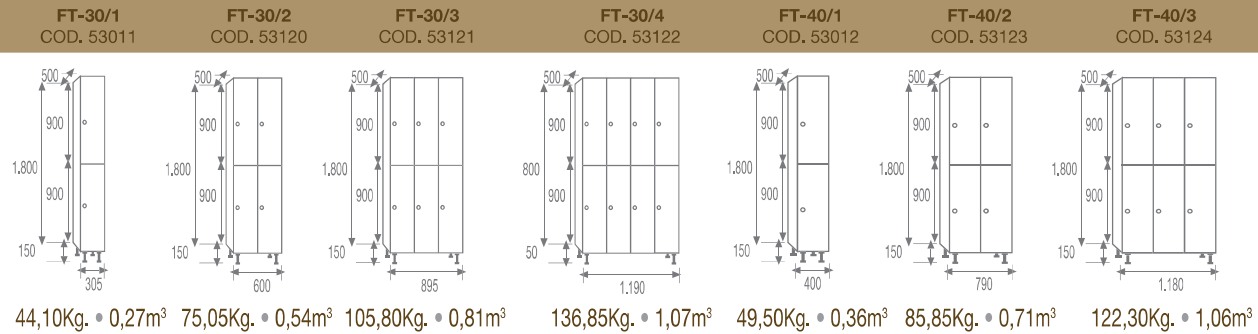

SERIE FM

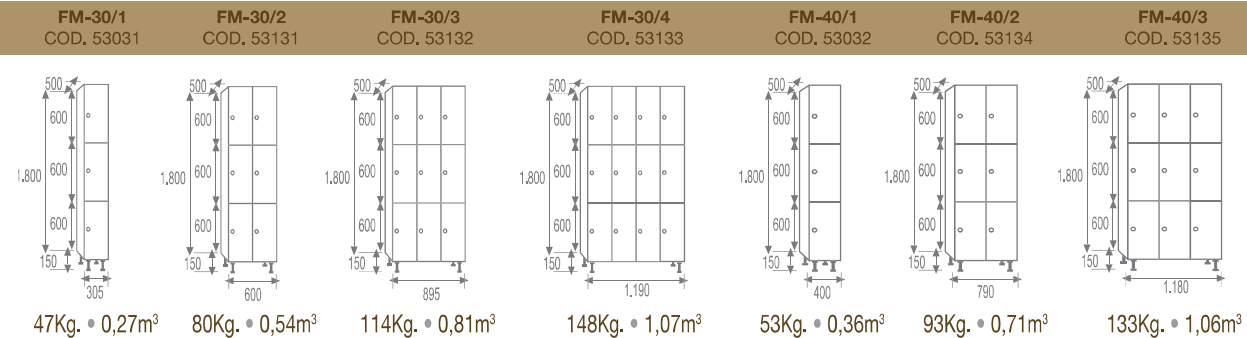

SERIE FC

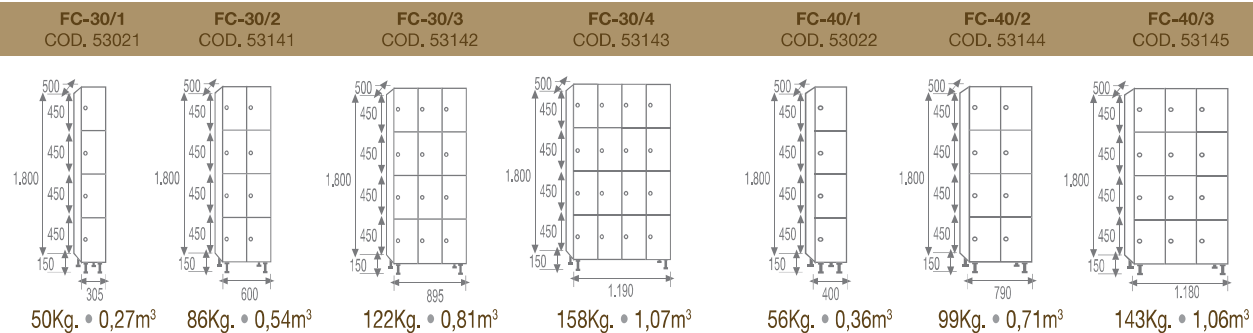

SERIE FP

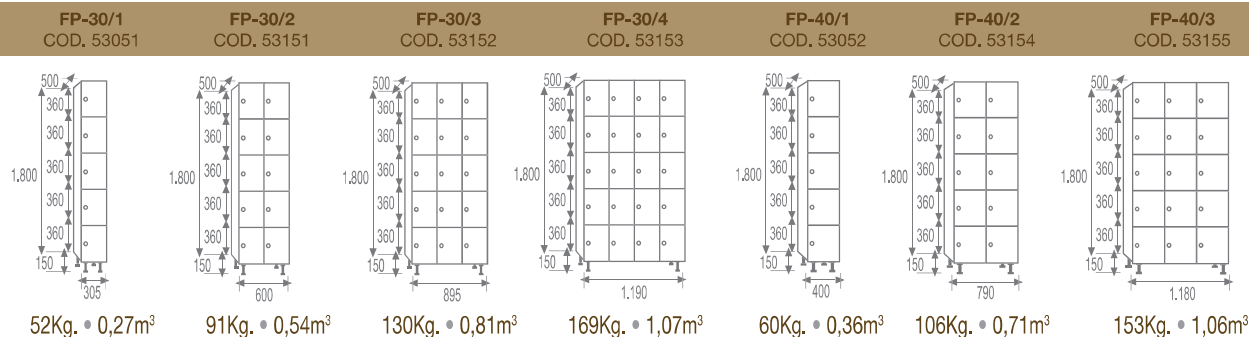

SERIE FB

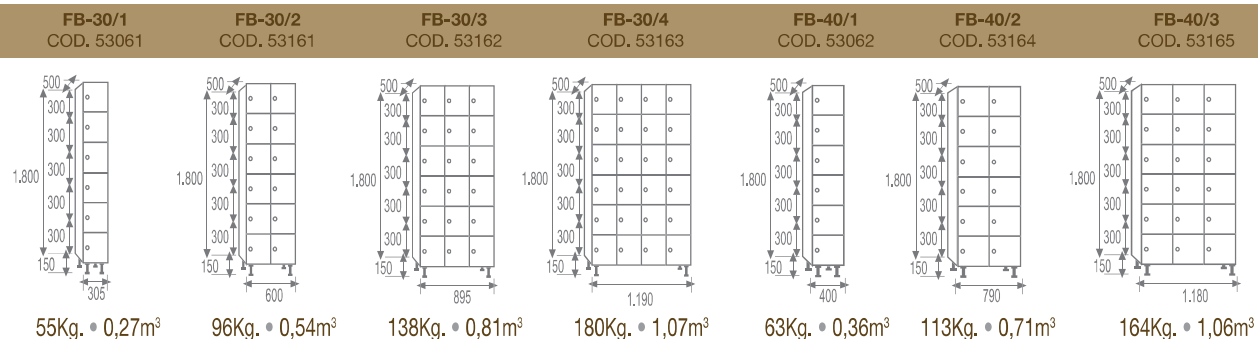

SERIE FZ

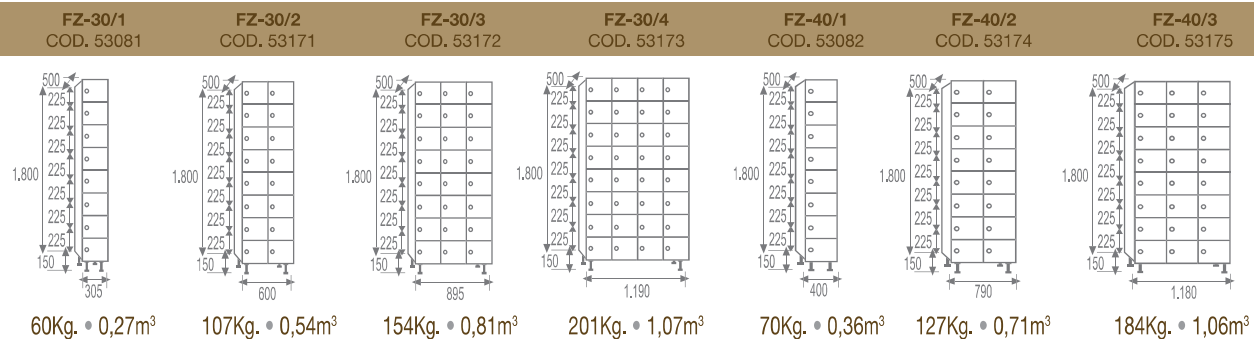

SERIE FL

